

VIKING

TECHNICAL Practice

TELECOM SOLUTIONS FOR THE 21ST CENTURY

SA-25

**Self Amplified Paging
Control Unit with
IR Remote**

January 3, 2013

Add Up to 25 Remote Controllable Self-Amplified Paging Speakers to Any Phone System

The **SA-25** can directly drive up to 25 self amplified speakers. Speakers can be Viking's 2 wire self amplified ceiling speaker model **SA-1S**, the **SA-1H** self amplified paging horn, the older 4 wire legacy Valcom and Bogen self amplified speakers, or any combination of the above. Viking self amplified speakers have these advantages: 1) Audio and power are on the same pair (less copper). 2) Power is 40VDC for lower current and smaller gauge wire (less copper). 3) Non-Polarity sensitive for easier wiring. 4) Each speaker is infrared remote controllable so there is no need to manage and wire "background music zones", install volume controls on the walls, or climb up ladders to adjust the volume. The provided **SA-IR** Infrared Remote controls volume, mute, and enable/disable background music at each speaker as required.

The **SA-25** provides paging, loud ringing, and background music when connected to electronic or 1A2 Key systems, PABX's, No-KSU phones, multi-line phones, as well as IP phone systems (that have an analog FXS or FXO port). The **SA-25** paging control unit can interface with a paging port or a ringing analog FXS, CO/Centrex line, PABX/KSU station port or an FXO, unused telephone line input (trunk port).

The **SA-25** will generate loud ringing from a ringing analog line or from a dry contact closure. Either a loud electronic warble sound or one of three other soft chime sounds may be selected. An external "night transfer" switch (such as Viking model **NS-1**) can be added to turn loud ringing on or off in night bell applications. If a music source is connected to the **SA-25**, background music can be enabled or disabled at any Viking self amplified speaker using the provided **SA-IR** infrared remote control. Background music is inhibited during paging. The **SA-25** is easy to install and comes complete with a power supply. The Viking model **SA-X12** Expander / Adapter can be used if additional self amplified speakers are required.



Features

- Includes (1) **SA-IR** Infrared Remote Control
- Easy to install
- Drive up to 25 self amplified speakers
- Separate volume controls for Auxiliary Input, Paging, Ringing Tones and Background Music
- Choose from up to 4 loud ringing sounds:
 - Electronic warble (traditional loud ringer)
 - Double gong (two identical "gong" tones)
 - Quadruple chime (four descending chime tones)
 - Door chime (ding-dong)
- Provides loud ringing or night bell
- Night transfer switch input
- Page from a ringing C.O. line, Centrex line, paging port, unused phone system trunk input (FXO), or ringing analog station port (FXS)
- Can provide background music from an external source
- 600 Ohm output to cascade to additional units
- Use multiple units to drive more self amplified speakers
- Expandable 12 speakers at a time with the Viking model **SA-X12** Expander / Adapter (**DOD# 529**)

Applications

- Amplified loud paging
- Loud ringing
- Night bell
- Background music
- Sound masking
- For unused phone system trunk input (FXO), ringing analog station port (FXS), C.O. line, Centrex line, or paging port

Specifications

- Power:** 120V AC/15V AC 2.2A UL listed adapter provided
- Dimensions:** 210mm x 159mm x 45mm (8.25" x 6.25" x 1.75")
- Shipping Weight:** 1.5kg (3.2 lbs.)
- Environmental:** 0°C to 32°C (32°F to 90°F) with 5% to 95% non-condensing humidity
- Paging Output:** Viking 40V two wire, and Valcom/Bogen 24V four wire protocols.
- Speakers:** Up to 25 self amplified speakers
- Talk Battery Output:** 40V DC (loop current 30mA nominal)
- Maximum Wire Run Length:** See chart on page 3
- Connections:** (1) 3.5mm (1/8") audio jack, (1) 2.1mm barrel jack (20) cage clamp screw terminals

IF YOU HAVE A PROBLEM WITH A VIKING PRODUCT, PLEASE CONTACT: VIKING TECHNICAL SUPPORT AT (715) 386-8666

Our Technical Support Department is available for assistance Monday 8am - 4pm and Tuesday through Friday 8am - 5pm central time. So that we can give you better service, before you call please:

1. Know the model number, the serial number and what software version you have (see serial label).
2. Have your Technical Practice in front of you.
3. It is best if you are on site.

RETURNING PRODUCT FOR REPAIR

The following procedure is for equipment that needs repair:

1. Customer must contact Viking's Technical Support Department at 715-386-8666 to obtain a Return Authorization (RA) number. The customer MUST have a complete description of the problem, with all pertinent information regarding the defect, such as options set, conditions, symptoms, methods to duplicate problem, frequency of failure, etc.
2. Packing: Return equipment in original box or in proper packing so that damage will not occur while in transit. Static sensitive equipment such as a circuit board should be in an anti-static bag, sandwiched between foam and individually boxed. All equipment should be wrapped to avoid packing material lodging in or sticking to the equipment. Include ALL parts of the equipment. C.O.D. or freight collect shipments cannot be accepted. Ship cartons prepaid to:
Viking Electronics, 1531 Industrial Street, Hudson, WI 54016
3. Return shipping address: Be sure to include your return shipping address inside the box. We cannot ship to a PO Box.
4. RA number on carton: In large printing, write the R.A. number on the outside of each carton being returned.

RETURNING PRODUCT FOR EXCHANGE

The following procedure is for equipment that has failed out-of-box (within 10 days of purchase):

1. Customer must contact Viking's Technical Support at 715-386-8666 to determine possible causes for the problem. The customer MUST be able to step through recommended tests for diagnosis.
2. If the Technical Support Product Specialist determines that the equipment is defective based on the customer's input and troubleshooting, a Return Authorization (R.A.) number will be issued. This number is valid for fourteen (14) calendar days from the date of issue.
3. After obtaining the R.A. number, return the approved equipment to your distributor, referencing the R.A. number. Your distributor will then replace the product over the counter at no charge. The distributor will then return the product to Viking using the same R.A. number.
4. **The distributor will NOT exchange this product without first obtaining the R.A. number from you. If you haven't followed the steps listed in 1, 2 and 3, be aware that you will have to pay a restocking charge.**

LIMITED WARRANTY

Viking warrants its products to be free from defects in the workmanship or materials, under normal use and service, for a period of one year from the date of purchase from any authorized Viking distributor or 18 months from the date manufactured, whichever ever is greater. If at any time during the warranty period, the product is deemed defective or malfunctions, return the product to Viking Electronics, Inc., 1531 Industrial Street, Hudson, WI., 54016. Customer must contact Viking's Technical Support Department at 715-386-8666 to obtain a Return Authorization (R.A.) number.

This warranty does not cover any damage to the product due to lightning, over voltage, under voltage, accident, misuse, abuse, negligence or any damage caused by use of the product by the purchaser or others.

NO OTHER WARRANTIES. VIKING MAKES NO WARRANTIES RELATING TO ITS PRODUCTS OTHER THAN AS DESCRIBED ABOVE AND DISCLAIMS ANY EXPRESS OR IMPLIED WARRANTIES OR MERCHANTABILITY OR FITNESS FOR ANY PARTICULAR PURPOSE.

EXCLUSION OF CONSEQUENTIAL DAMAGES. VIKING SHALL NOT, UNDER ANY CIRCUMSTANCES, BE LIABLE TO PURCHASER, OR ANY OTHER PARTY, FOR CONSEQUENTIAL, INCIDENTAL, SPECIAL OR EXEMPLARY DAMAGES ARISING OUT OF OR RELATED TO THE SALE OR USE OF THE PRODUCT SOLD HEREUNDER.

EXCLUSIVE REMEDY AND LIMITATION OF LIABILITY. WHETHER IN AN ACTION BASED ON CONTRACT, TORT (INCLUDING NEGLIGENCE OR STRICT LIABILITY) OR ANY OTHER LEGAL THEORY, ANY LIABILITY OF VIKING SHALL BE LIMITED TO REPAIR OR REPLACEMENT OF THE PRODUCT, OR AT VIKING'S OPTION, REFUND OF THE PURCHASE PRICE AS THE EXCLUSIVE REMEDY AND ANY LIABILITY OF VIKING SHALL BE SO LIMITED.

IT IS EXPRESSLY UNDERSTOOD AND AGREED THAT EACH AND EVERY PROVISION OF THIS AGREEMENT WHICH PROVIDES FOR DISCLAIMER OF WARRANTIES, EXCLUSION OF CONSEQUENTIAL DAMAGES, AND EXCLUSIVE REMEDY AND LIMITATION OF LIABILITY, ARE SEVERABLE FROM ANY OTHER PROVISION AND EACH PROVISION IS A SEPARABLE AND INDEPENDENT ELEMENT OF RISK ALLOCATION AND IS INTENDED TO BE ENFORCED AS SUCH.

Features Overview

⚠ IMPORTANT: Electronic devices are susceptible to lightning and power station electrical surges from both the AC outlet and the telephone line. It is recommended that a surge protector be installed to protect against such surges.

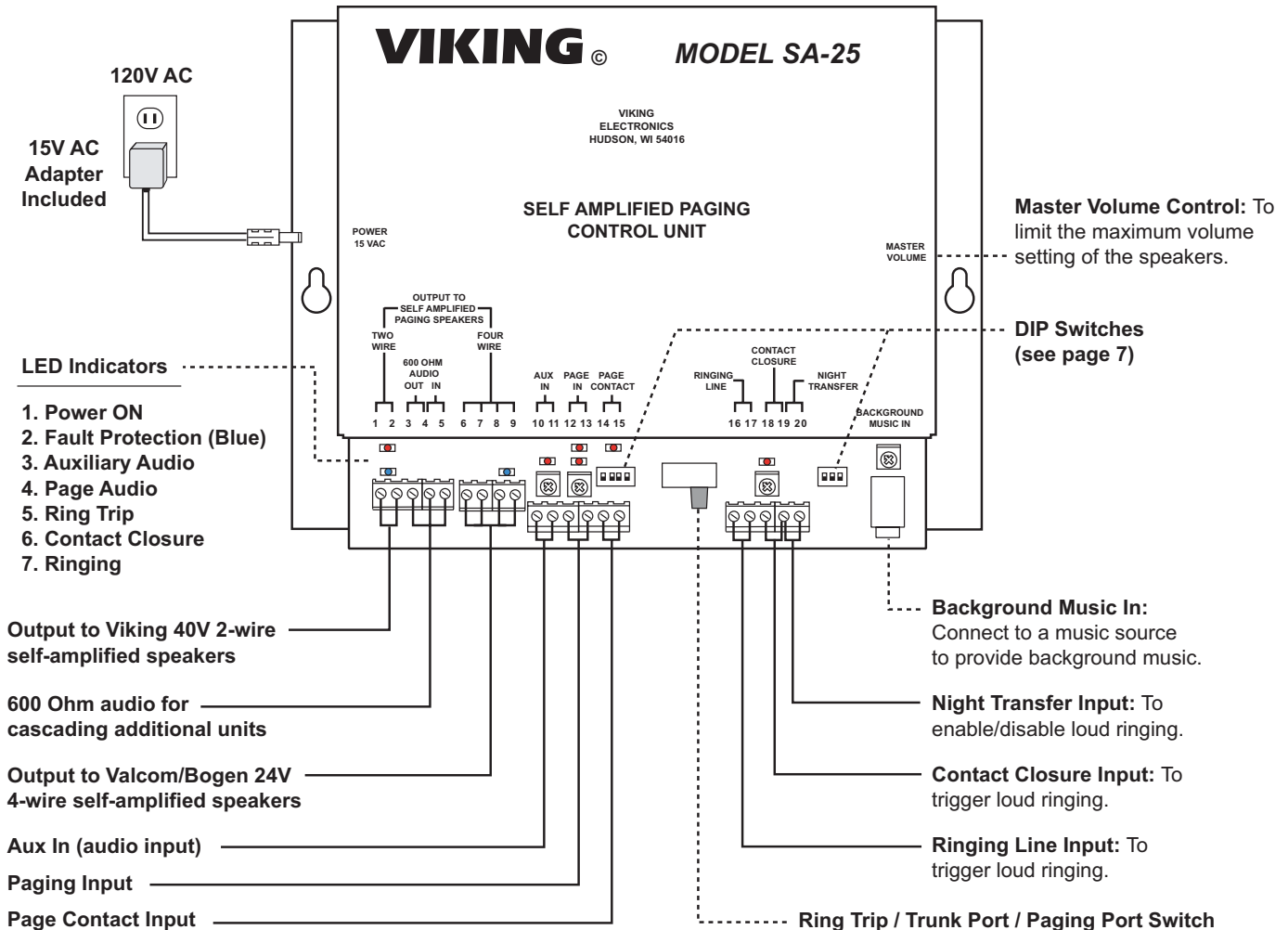

Installation and Programming

A. Wiring Self-Amplified Speakers

1. Viking SA Series Two-Wire Speakers

Step 1.	Determine the wire run length and number of SA-1S self-amplified ceiling speakers, and/or SA-1H self-amplified paging horns for each run.
Step 2.	Use the chart below to determine the minimum recommended wire gauge to use.
Step 3.	Wire each run to pins 1 and 2.
Step 4.	Adjust the volume of each speaker with the Viking SA-IR Infrared Remote Control.
Step 5.	Use the Master Volume control to limit the maximum speaker volume when the infrared remote has them turned up all the way.

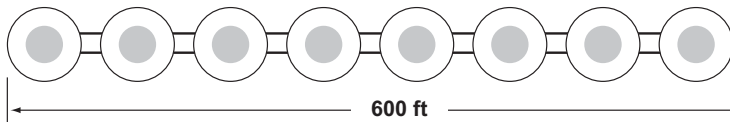
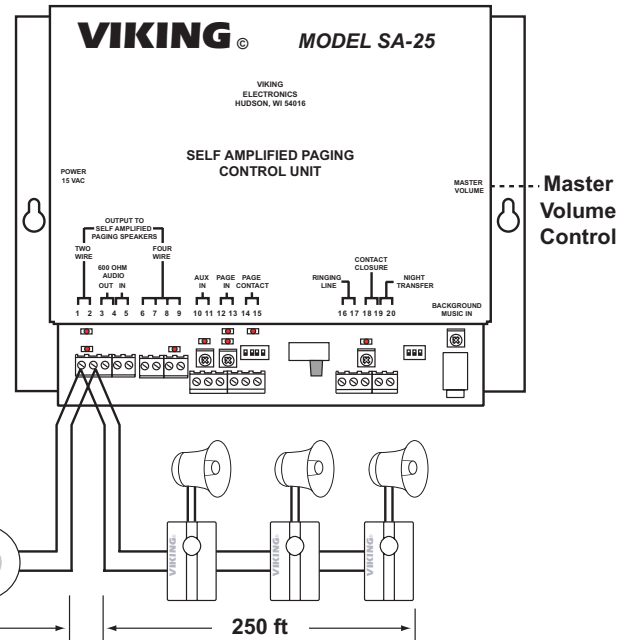

Example: Eight (8) **SA-1S** speakers on a 600 ft long wire run. Use at minimum #18 AWG copper wire pair as recommended in the chart below.

Example: Three (3) **SA-1H** horns on a 250 ft long wire run. Use at minimum #24 AWG copper wire pair as recommended in the chart below.

Recommended Minimum AWG (American Wire Gauge) Size for Viking SA-1S Self-Amplified Speakers on a Two-Wire Run

Number of Speakers on the Two-Wire Run	25	#24	#18	#16	#16										
	20	#24	#20	#18	#18	#16									
	16	#24	#22	#20	#20	#16	#16								
	12	#24	#24	#24	#22	#18	#18	#16							
	10	#24	#24	#24	#24	#20	#18	#18	#16						
	8	#24	#24	#24	#24	#22	#20	#18	#16	#16					
	6	#24	#24	#24	#24	#24	#24	#22	#20	#18	#16				
	5	#24	#24	#24	#24	#24	#24	#24	#20	#20	#18	#16			
	4	#24	#24	#24	#24	#24	#24	#24	#22	#20	#18	#16	#16		
	3	#24	#24	#24	#24	#24	#24	#24	#24	#24	#22	#20	#18	#16	
	2	#24	#24	#24	#24	#24	#24	#24	#24	#24	#24	#24	#22	#20	#18
	1	#24	#24	#24	#24	#24	#24	#24	#24	#24	#24	#24	#24	#24	#24
			100	200	250	300	400	500	600	800	1000	1200	1600	2000	2500

Total Distance of Two-Wire Run in Feet

2. Bogen or Valcom Four-Wire Speakers

The **SA-25** is backwards compatible with legacy four-wire self-amplified loud speakers such as those from Bogen or Valcom. Use wire gauge size chart on previous page, but go two sizes larger since 24V power has more current loss than Vikings 40V two wire protocol. For example, the chart says to use #16 gauge wire for 8 speakers on a 1000 foot run; but instead use #14 gauge wire when using Valcom and Bogen legacy speakers. The **SA-25** can power up to 25 Bogen or Valcom speakers (equal to 25 "Valcom Power Units"), if no Viking SA series two wire speakers are used. If a combination of Viking SA series two wire speakers and Bogen or Valcom speakers are used, the **SA-25** can power up to a combined total of 25 speakers. Larger systems can be achieved by adding Viking model **SA-X12** for more Viking SA series two wire speakers, and/or adding a Bogen or Valcom 24V power supply for more 4 wire speakers.

Step 1.	Wire the Red & Green (tip and ring) pair of wires to screw terminals 6 & 7.
Step 2.	Wire the Yellow & Black (24V power) pair of wires to screw terminals 8 & 9.
Step 3.	Adjust volume manually at each speaker.

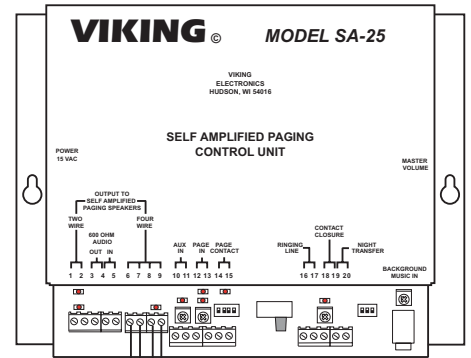
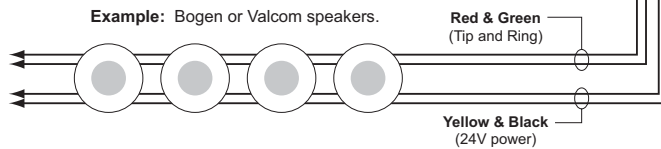

B. Amplified Loud Paging

1. Paging Port

Step 1.	Move the TALK BATTERY DIP switch to the OFF position (DIP switch 1).
Step 2.	Move slide switch to PAGING PORT .
Step 3.	Connect pins 12 and 13 to the paging port output.
Step 4.	Connect pins 14 and 15 to the paging contacts (if available).
Step 5.	Adjust the page level trim pot so the Page LED flashes with page audio (see Operation page 8).

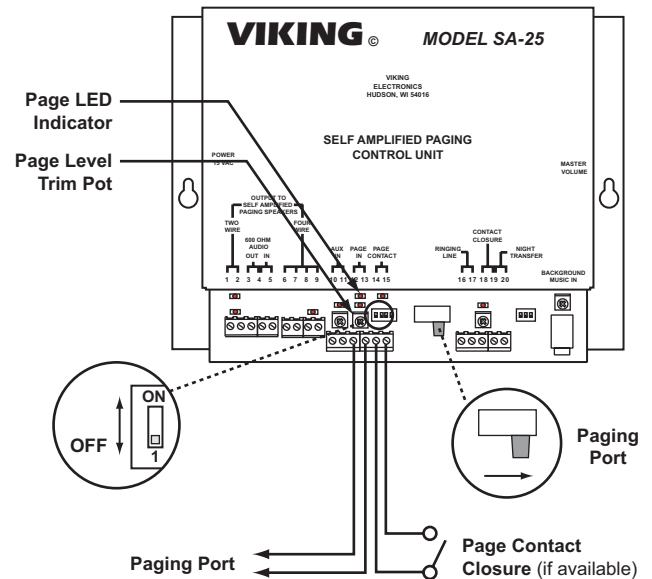

2. Trunk / Line Port / FXO

Step 1.	Move the TALK BATTERY DIP switch to the ON position (DIP switch 1).
Step 2.	Move slide switch to TRUNK PORT .
Step 3.	Connect pins 12 and 13 to an unused telephone line input (trunk port).
Step 4.	Adjust the page level trim pot so the page LED flashes with page audio (see Operation page 8).

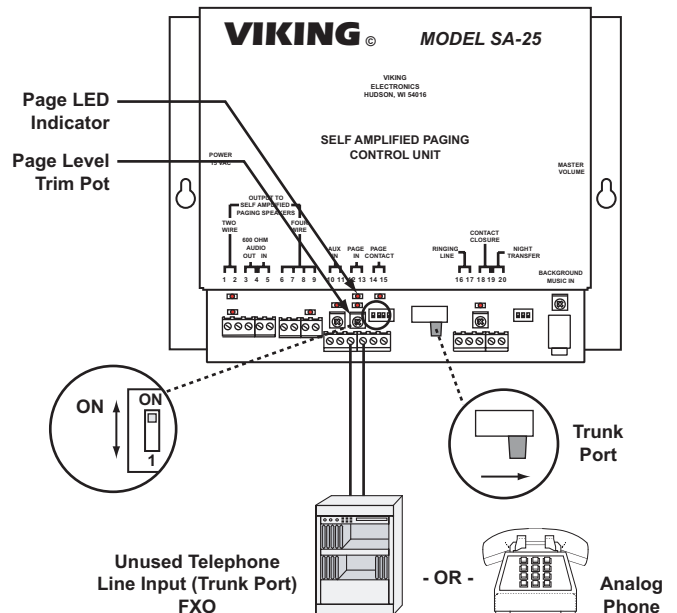

3. Ring Trip / FXS

Step 1.	Move the TALK BATTERY DIP switch to the OFF position (DIP switch 1).
Step 2.	Move slide switch to RING TRIP .
Step 3.	Connect pins 12 and 13 to a ringing analog station port (FXS).
Step 4.	Adjust the page level trim pot so the Page LED flashes with page audio (see Operation page 8).

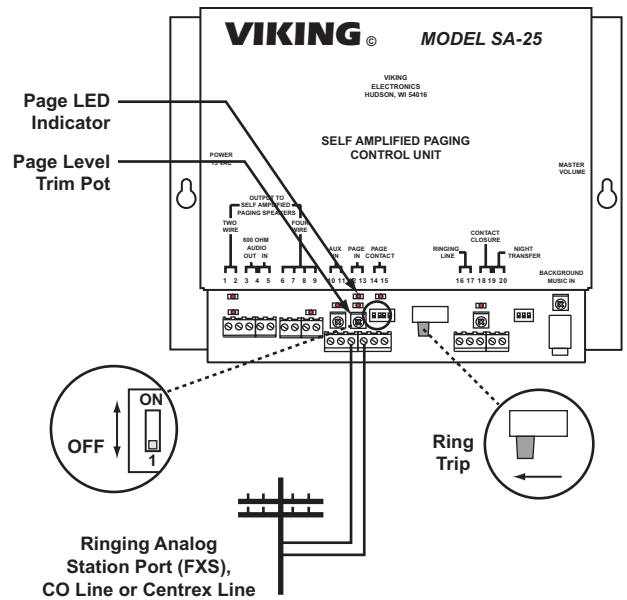

C. Loud Ringing/Night Bell

1. Ringing Analog Lines

Step 1.	Connect pins 16 and 17 to a ringing line or PABX station.
Step 2.	The loud ringing pot may be adjusted to set volume.
Step 3.	A night transfer switch may be added to pins 19 and 20 to enable and disable loud ringing.

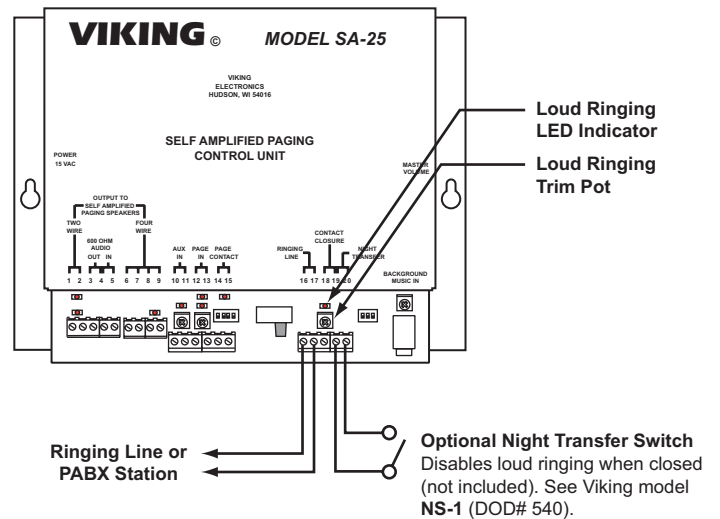

2. Dry Contact (Common Audible) Closure (contacts not included)

Step 1.	Connect the dry contact closure to pins 18 and 19 .
Step 2.	A dry contact closure will initiate loud ringing.

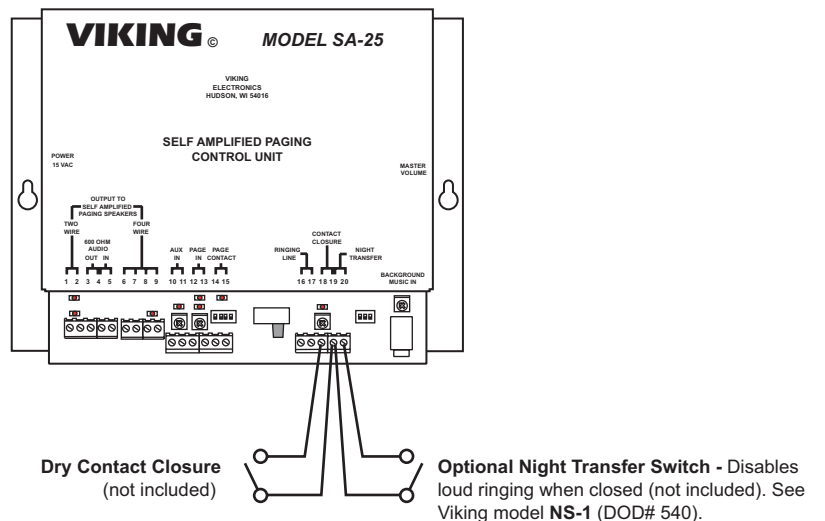

D. Auxiliary Input

Step 1.	Connect pins 10 and 11 to any other line level audio source.
Step 2.	Adjust the Aux In level trim pot so the Aux In LED flashes with aux audio (see Operation page 8).

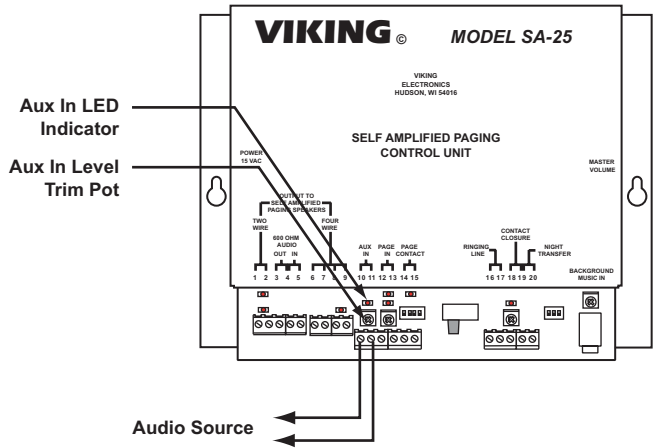

E. Background Music

Step 1.	Connect a background music source to the background music in jack using the 1/8" (3.5mm) cable provided.
Step 2.	Adjust the background music trim pot to the desired volume.
Step 3.	Background music will play when all other inputs are idle.

* **Note:** If your music source provides a 1/8" stereo output, you might need a mono to stereo adapter.

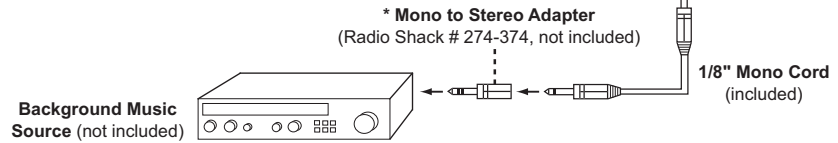
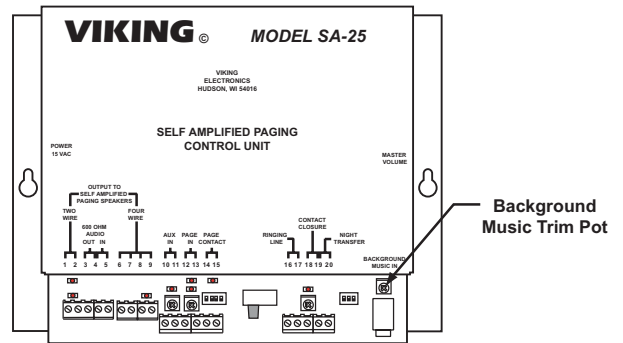

F. Adding More Viking Self-Amplified Paging Speakers

When more than (25) self-amplified paging speakers are required, a second **SA-25** for (25) more speakers, or the Viking model **SA-X12** Expander can be used to add (12) self-amplified paging speakers. For more information on the **SA-X12**, see DOD# 529.

Step 1.	Connect the SA-25 600 Ohm Output (pins 3 & 4) to the 600 Ohm Audio Input (pins 5 & 6) on the SA-X12 or pins 4 & 5 on the SA-25 .
Step 2.	Connect up to (12) self-amplified speakers to a SA-X12 Expander, or (25) to a SA-25 .
Step 3.	Adjust the volume control of the SA-X12 if needed.

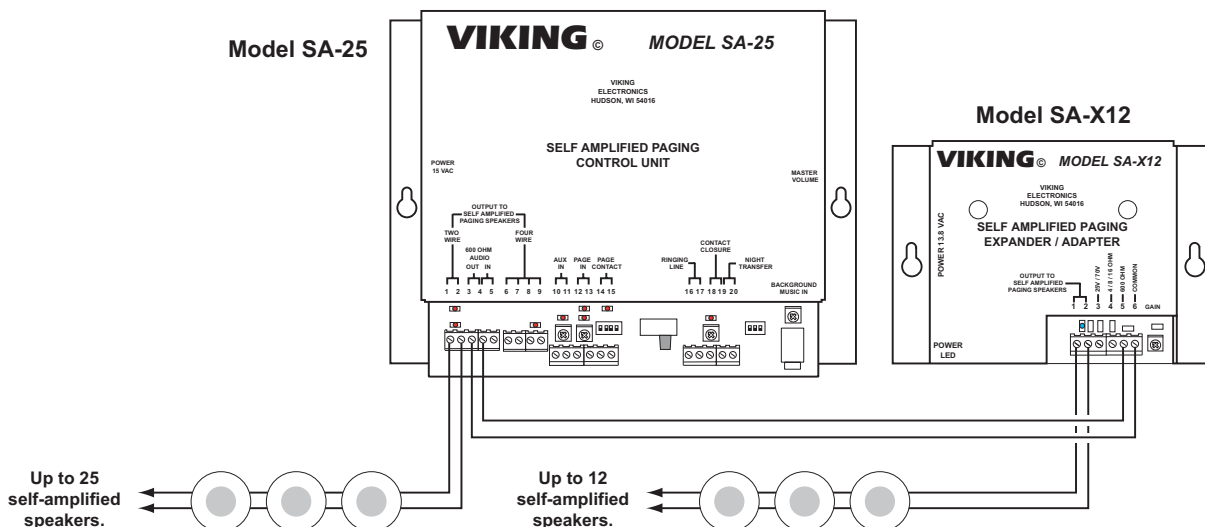

G. DIP Switch Programming

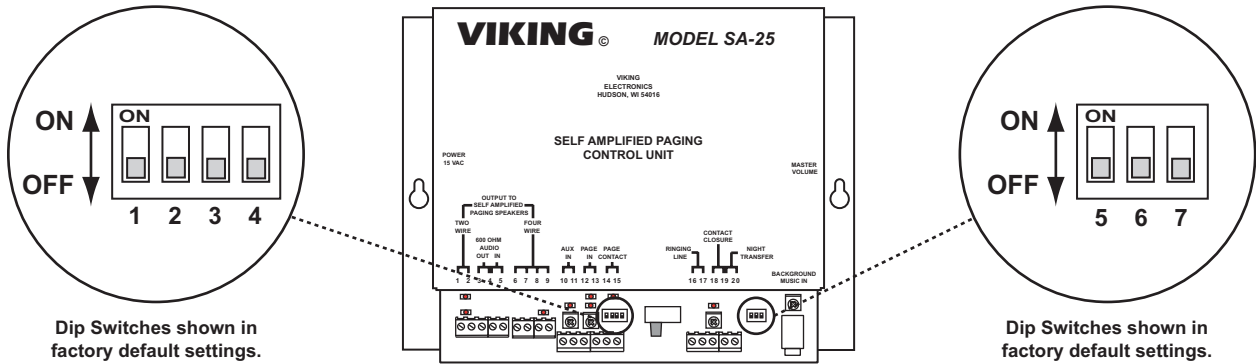

Switch	Position	Description
1	OFF	Talk battery disabled (use for Paging Port and Ring Trip)
1	ON	Talk battery enabled (use for Trunk Port)
2	OFF	Normal priority: Aux In → Page → Ringing → Background music
2	ON	Alternative priority: Page → Aux In → Ringing → Background music
3	OFF	Pre page alert tone disabled
3	ON	Pre page alert tone enabled
4	OFF	Post page alert tone disabled
4	ON	Post page alert tone enabled

Switch 5	Switch 6	Loud Ringing Sound Output
OFF	OFF	Electronic warble
OFF	ON	Double gong
ON	OFF	Quadruple chime
ON	ON	Door chime

Switch 7	Description
OFF	Normal mode (see Operation section H)
ON	Smart mode (see Operation section H)

Sound Output Specifications

All tones require a minimum of 180ms of ringing voltage (or contact closure) to trigger. Once triggered, the electronic warble will run continuously until ringing stops (or contacts open). All other tones (double gong, quadruple chime, doorbell) will run through their full sequence once and will not cycle again until the ringing stops (or contact opens) for at least 50ms and a second ring signal (or contact closure) triggers them again.

A. Electronic Warble (Traditional Loud Ringer)

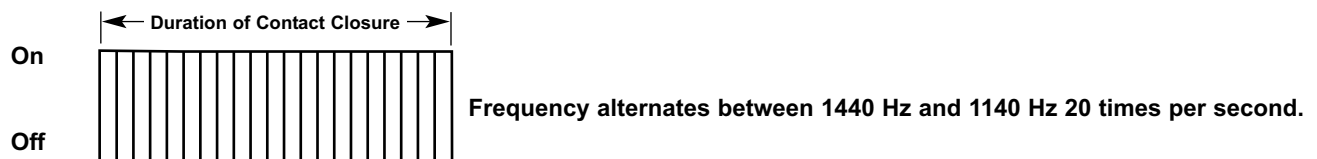

B. Double Gong (Two "Gong" Tones)

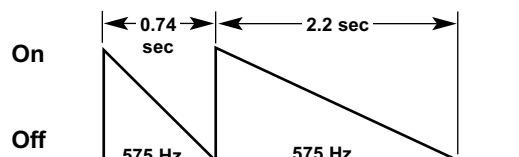

C. Quadruple Chime (Four Descending Chime Tones)

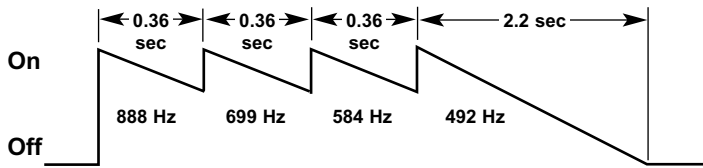

D. Door Chime (Ding-Dong)

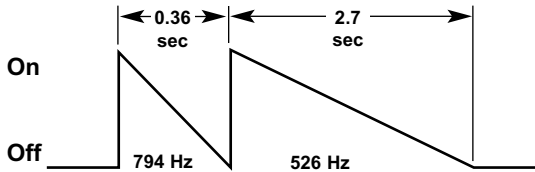

Operation

A. Background Music In

This audio input allows background music from an external source to plug into the **SA-25**. While any other input is active, background music is turned off, so music will only be heard through the speakers when all other inputs are idle. A 3.5mm (1/8") audio cable is provided, and the music level can be set using the trim POT just behind the Background Music input jack.

B. Loud Ringing

1. Line In

This input provides loud ringing through the speakers whenever ringing voltage is detected. Connect an analog ringing line to screw terminals 16 & 17 for this feature.

2. Contact Closure

This input provides loud ringing through the speakers whenever a contact closure is detected. Some phone systems provide a "common audible" dry contact closure whenever a call is coming in. Wire the contact closure across screw terminals 18 & 19 to provide loud ringing from the **SA-25**.

3. Night Transfer

This input can be used to disable loud ringing. For example, if loud ringing is only necessary during off business hours, an external switch can be added to disable loud ringing during the day, and transfer it back on at night. Wire an external switch (such as Viking model **NS-1**) across screw terminals 19 & 20. When the switch is closed, loud ringing will be disabled.

4. Loud Ringing Sounds

The **SA-25** can produce one of 4 selectable loud ringing sounds. Use DIP Switches 5 and 6 to choose between Electronic Warble, Double Gong, Quadruple Chime, or Door Chime sounds for loud ringing. Select the Electronic Warble tone (traditional loud ringing) for noisy areas. The softer chime tones work well in less noisy environments.

C. Paging In

This audio input allows paging from a ringing analog station port (FXS), CO line or Centrex line, a phone system's unused trunk/line input (FXO) or dedicated telephone, or a paging port. Wire the appropriate page source to screw terminals 12 & 13 as shown in the Installation section, and follow the operation for your type of paging as described below.

1. Ringing Analog Station (FXS), C.O. Line, or Centrex Line

If paging from a ringing analog station (FXS), C.O. line, or Centrex line, DIP Switch 1 must be OFF, and the Slide Switch set to **RING TRIP**. Dial the station or phone line number, and the **SA-25** will answer the line after the first ring is detected. Wait for the Pre-Page Alert Tone to pass (if enabled), and then speak. The **SA-25** will drop the line once it detects silence, busy signal, reorder signal, or a CPC break. If none of those are detected, the **SA-25** will drop the line at a default time out of 60 seconds.

2. Unused Trunk/Line Input (FXO), or Dedicated Analog Telephone

If paging from a phone system's unused trunk/line input (FXO), or a dedicated analog telephone, DIP Switch 1 must be turned ON (so the **SA-25** will provide the necessary 40V DC Talk Battery), and the Slide Switch set to **TRUNK**. To page, either access that trunk port or go off hook on the analog telephone. Loop current will be detected and activate paging. Wait for the Pre-Page Alert Tone to pass (if enabled), and then speak.

The **SA-25** will automatically provide a CPC signal to the phone system if the trunk port has not dropped within 60 seconds. If a user fails to release the trunk after making a page, the CPC signal acts as a safety net to clear the trunk so it will be available for the next page.

3. Paging Port with Page Contacts

When using a phone system's paging port, if a page contact closure is available from the phone system, wire the contacts to screw terminals 14 & 15. DIP Switch 1 must be turned OFF and the Slide Switch set to **PAGING**. To page, simply access the phone system's paging port, (the contact closure will activate the **SA-25**'s paging input). Wait for the Pre-Page Alert Tone to pass (if enabled), and then speak.

4. Paging Port without Page Contacts

DIP Switch 1 must be turned OFF and the Slide Switch set to **PAGING**. When paging from a paging port and there are no page contacts available, the **SA-25** relies on its internal Voice Activation Switch (VOX) feature to switch to paging when voice audio is detected. This means the voice audio must be loud enough to be detected. The VOX sensitivity can be adjusted using the Page Level Trim Pot located just behind the Page In screw terminals. Adjust this Pot so the Page LED flashes with page audio. A pre-page alert tone would not happen until the person starts talking, so it is recommended that the Pre-Page Alert Tone is disabled (set DIP Switch 3 to OFF), unless using the below Tip. To page, simply access the phone system's paging port and speak.

*Tip: When relying on VOX activation, the very beginning of the page will be cut off. If this is objectionable, the user can make some sort of sound (like pressing a touch tone, or saying the word "paging") to activate the VOX before speaking. This will be especially helpful when using the **SA-25** in the Smart Mode where an extra fraction of a second is needed for the **SA-25** to signal the speakers that have been muted for no background music, to turn themselves back on.*

D. Aux In

This audio input allows any additional audio sources to be connected into the **SA-25** on screw terminals 10 & 11. Possible uses are: audio from another paging system, clock controlled tones to announce work shift times (see Viking model **CTG-1**), emergency siren (see Viking model **DNA-510** or **MTG-10**), digitally recorded announcements (see Viking model **DVA-500A** or **DVA-2WA**), etc.

The **SA-25** relies on its internal Voice Activation Switch (VOX) feature to switch to the Aux Input when audio is loud enough to be detected. The VOX sensitivity can be adjusted using the Aux In Level Trim Pot located just behind the Aux In screw terminals. Adjust this Pot so the Aux In LED flashes with Aux audio. When relying on VOX activation, the very beginning of the audio will be cut off. This will be especially noticeable when using the **SA-25** in the Smart Mode, where an extra fraction of a second is needed for the **SA-25** to signal the speakers that have been muted for no background music to turn themselves back on.

E. 600 Ohm Output / Input

This audio output / input is provided so that a **SA-X12** or a **SA-25** can be added if additional self-amplified speakers are needed.

F. Master Volume

A master volume control is provided. Use this to limit the maximum speaker volume of the self-amplified speakers when the infrared remote has them turned all the way up.

G. Priorities

Since there are multiple uses and inputs to the **SA-25**, priorities need to be established to prevent contentions. If two inputs are activated at the same time, the one with the highest priority will take effect. Examples: Paging is higher priority than Loud Ringing, so Paging would interrupt loud ringing tones. The Background Music input is always the lowest priority, and thus can be interrupted by any other input. Two different DIP Switch programmable Priority selections are available as listed below.

Normal Priority (DIP Switch 2 OFF)

1. Aux In
2. Paging
3. Ringing
4. Background Music

Alternative Priority (DIP Switch 2 ON)

1. Paging
2. Aux In
3. Ringing
4. Background Music

H. Infrared Remote Control

Infrared remote control is one of several features that set Viking's self amplified paging system ahead of older legacy Valcom and Bogen systems. These older 4 wire self amplified systems required twice the copper to each speaker than Viking's 2 wire system. The older 4 wire systems also required the installer to manage background music zones, and hardwire each speaker to one zone or the other, and then have to walk around with a ladder to manually set the volume of each speaker to hopefully the proper level. If the user decides one of the speakers should now have background music or a volume adjustment, it's back up the ladder to pull more wire, and adjust more pots.

With the Viking **SA Series** 2 wire self amplified paging system, the installer can connect all the speakers to the same pair of wires, and then simply show the user how to point the **SA-IR** Infrared Remote control at each speaker to adjust volume, mute, and enable or disable background music.

The Viking model **SA-1S** and **SA-1H** self amplified speakers can be controlled with the Viking model **SA-IR** Infrared Remote control in one of two different ways depending on a DIP Switch setting on the **SA-25** as described below.

1. SA-IR Remote Control functionality with SA-25 in "Normal" mode (DIP Switch 7 = OFF):

The **SA-IR** Remote Control functions essentially like a TV remote control. Each individual speaker volume can be stepped up or down, or the speaker can be totally muted. When the speaker is muted, pressing the mute button again, or the volume up or down buttons, will release the mute. A short "beep" will be heard through the speaker when the mute is activated. A long "beep" will be heard through the speaker when the "MUTE" button is pressed again releasing the mute. The "Normal" mode is recommended when no background music is used.

2. SA-IR Remote Control functionality with SA-25 in the "Smart" mode (DIP Switch 7 = ON):

The "Smart" mode is recommended for installations that use background music. In this special mode the **SA-IR** Remote Control "MUTE" button functions as a "mute background music button". Press the "MUTE" button while background music is playing and no background music will be heard through that speaker; yet all paging and loud ringing sound will still be amplified through the speaker. This feature is useful for speakers which are mounted in a meeting room in which pages need to be heard, but background music would be obstructive, or offices in which enabling and disabling background music on a speaker by speaker basis is needed. This feature enables an office with background music to become a quiet meeting room with the push of a button.

In this "Smart" mode, if the **SA-IR** Remote Control "MUTE" button is pressed during paging or loud ringing, it will immediately totally mute that speaker. No other pages, loud ringing, or background music will be heard from that speaker until it is un-muted using the remote control's "MUTE" or "VOLUME" buttons. Another way to quiet a speaker is to step the volume all the way down to minimum while background music is playing.

A short "beep" will be heard through the speaker when the mute is activated. A long "beep" will be heard through the speaker when the "MUTE" button is pressed again releasing the mute. When the mute is released, all paging and loud ringing sounds as well as background music will be heard through that speaker.

Compatible Products



SA-1S

Self-Amplified Ceiling Speaker
For more info, see **DOD# 525**



SA-IR

Infrared Remote Control
For more info, see **DOD# 527**



SA-1H

Self-Amplified Paging Horn
with Infrared Receiver
For more info, see **DOD# 526**



SA-X12

Expander / Adapter
For more info, see **DOD# 529**

Product Support Line...715.386.8666

Fax Back Line...715.386.4345

Due to the dynamic nature of the product design, the information contained in this document is subject to change without notice. Viking Electronics, and its affiliates and/or subsidiaries assume no responsibility for errors and omissions contained in this information. Revisions of this document or new editions of it may be issued to incorporate such changes.